

Article number: 4395000321

Description: Rota-fix shaft-hub connection F32x60
Stainless steel

Measures

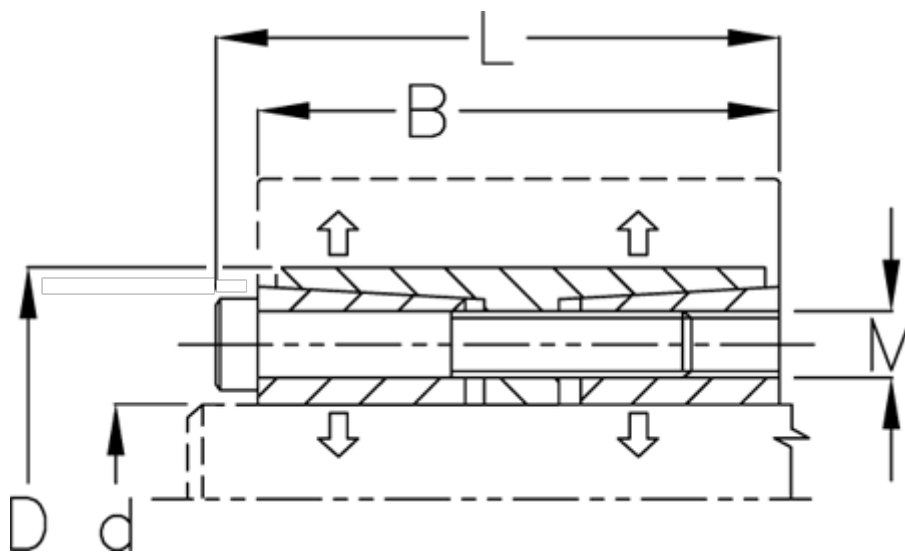

B mm	= 54
d H8 mm	= 32
D mm	= 60
Fit tolerance	= Aksel h8, Nav H8
F kN torque	= 41.3
L mm	= 60
M mm	= M6
P N/mm ² surface pressure on shaft/hub	= 26

Surface roughness	= R? ? 3.2 µm
T N m torque	= 660
Ts N m bolt tightening torque	= 11.8